



FSK 8.10 16 SKM10X25 STTZN (380 020)

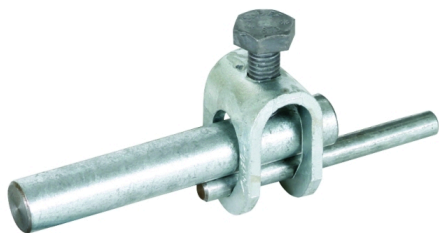
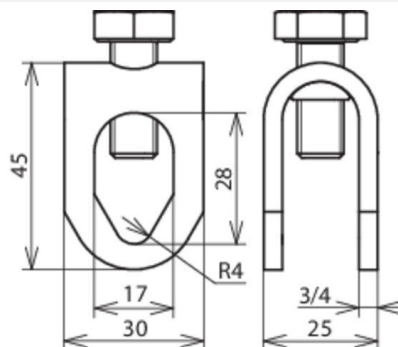

Figure without obligation



Application note:

for lengthwise connection for all conductor materials, crosswise connection (without inserting) only for St/tZn and StSt (Rd 8-10 mm)



Arrangement:

Type	FSK 8.10 16 SKM10X25 STTZN
Part No.	380 020
Material of clamp	St/tZn
Clamping range Rd / Rd	8-10 / 16 mm
Screw	M10 x 25 mm
Material of screw	St/tZn
Lightning current carrying capability (10/350 μs)	100 kA *)
Standard	EN 62561-1
Weight	86 g
Customs tariff number (Comb. Nomenclature EU)	85359000
GTIN	4013364066373
PU	50 pc(s)

*) For exact assignment, see test certificate.

We reserve the right to introduce changes in performance, configuration and technology, dimensions, weights and materials in the course of technical progress. The figures are shown without obligation.