



KS 8.10 8.10 FL30 ZP FRSM8 V4A (318 229)

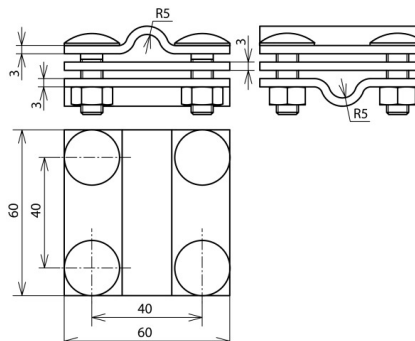
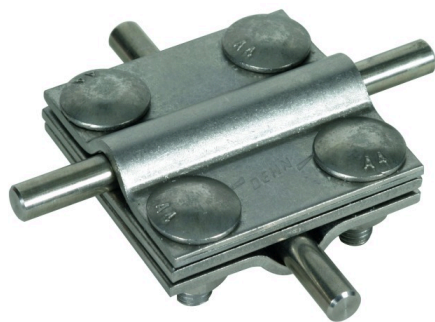

Figure without obligation



Arrangement:

Type	KS 8.10 8.10 FL30 ZP FRSM8 V4A
Part No.	318 229
Material of clamp	StSt (V4A)
ASTM / AISI:	316Ti / 316L / 316
Clamping range Rd / Rd	8-10 / 8-10 mm
Clamping range Rd / FI	8-10 / 30 mm
Clamping range FI / FI	30 / 30 mm
Clamping range (stranded / cable)	35-70 mm ²
Screw	M8 x 25 mm
Material of screw / nut	StSt (V4A)
Material No.	1.4571 / 1.4404 / 1.4401
ASTM / AISI:	316Ti / 316L / 316
Dimensions	60 x 60 x 3 mm
Intermediate plate	yes
Lightning current carrying capability (10/350 µs)	100 kA ^{*)}
Standard	EN 62561-1
Short-circuit current (a.c. 50 Hz / d.c.) (1 s; ≤ 300 °C)	7 kA
Weight	323 g
Customs tariff number (Comb. Nomenclature EU)	85359000
GTIN	4013364159938
PU	25 pc(s)

^{*)} See test certificate for exact classification.

We reserve the right to introduce changes in performance, configuration and technology, dimensions, weights and materials in the course of technical progress. The figures are shown without obligation.