

LH DG 8 H32 IGM6 CU (207 037)

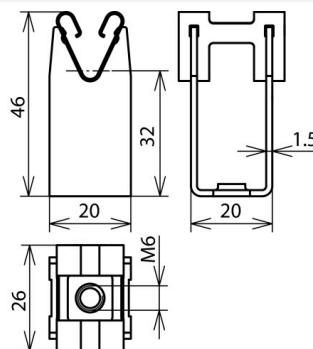

Figure without obligation



Type	LH DG 8 H32 IGM6 CU
Part No.	207 037
Height of conductor holder	32 mm
Thread of conductor holder	M6
Material of conductor holder	Cu
Conductor support Rd	8 mm
Conductor routing	loose
Standard	EN 62561-4
Weight	26 g
Customs tariff number (Comb. Nomenclature EU)	85389099
GTIN	4013364042742
PU	50 pc(s)

We reserve the right to introduce changes in performance, configuration and technology, dimensions, weights and materials in the course of technical progress. The figures are shown without obligation.