

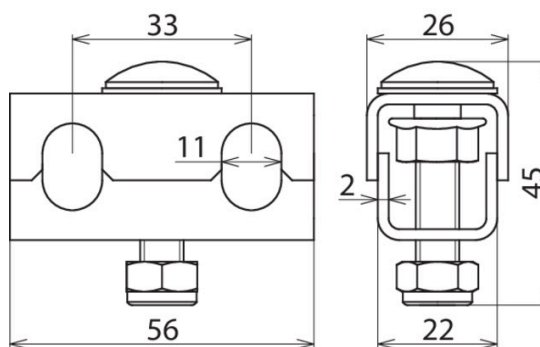

PAK 70 M8 EX KB ER (306 202)



Figure without obligation



Equipotential bonding clamp for cable trays

- Connection only with ring equipotential bonding conductor 70 mm², Part No. 832 292 (tinned copper cable)
- For mounting on the perforated cable tray or on the EB plate (PAP 1 / PAP 2)
- EB clamp to be mounted approx. every 0.5 m

Type	PAK 70 M8 EX KB ER
Part No.	306 202
Material	StSt
Connection to	PAP 1 EX KB ER or PAP 2 EX KB ER or cable tray or wide span cable tray
Clamping range EB ring conductor	70 mm ² , Cu/gal Sn
Screw	M8 x 40 mm
Material of screw / nut	StSt
Material No.	1.4301
ASTM / AISI:	AISI 304
EX zone	2/22
Short-circuit current AC (50 Hz / 5 s)	1.5 kA
Short-circuit current DC (5 s)	250 A
Weight	71 g
Customs tariff number (Comb. Nomenclature EU)	85359000
GTIN	4013364327351
PU	50 pc(s)

We reserve the right to introduce changes in performance, configuration and technology, dimensions, weights and materials in the course of technical progress. The figures are shown without obligation.