

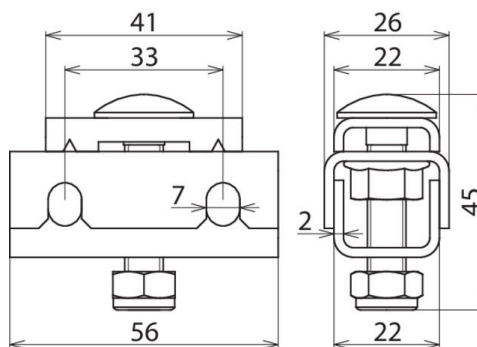

PAK 35 M8 EX GI ER (306 203)



Figure without obligation



Equipotential bonding clamp for wire cable trays

- Connection only with ring equipotential bonding conductor 35 mm², Part No. 832 838 (tinned copper cable)
- For mounting on the wire cable tray or on the equipotential bonding plate (PAP 1 / PAP 2)
- Equipotential bonding clamp to be mounted approx. every 0.5 m

Type	PAK 35 M8 EX GI ER
Part No.	306 203
Material	StSt
Connection to	PAP 1 EX GI ER / PAP 2 EX GI ER or wire cable tray
Clamping range EB ring conductor	35 mm ² , Cu/gal Sn
Screw	M8 x 40 mm
Material of screw / nut	StSt
Material No.	1.4301
ASTM / AISI:	AISI 304
EX zone	2/22
Short-circuit current AC (50 Hz / 5 s)	1.5 kA
Short-circuit current DC (5 s)	250 A
Weight	74 g
Customs tariff number (Comb. Nomenclature EU)	85359000
GTIN	4013364327382
PU	50 pc(s)

We reserve the right to introduce changes in performance, configuration and technology, dimensions, weights and materials in the course of technical progress. The figures are shown without obligation.