

AK 6.10 KSV FER S KBF18 35 V2A (372 179)

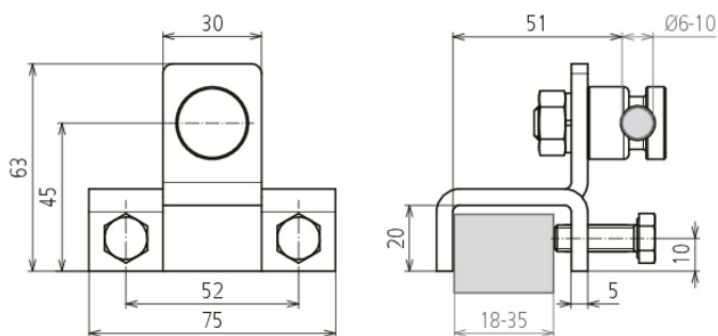

Figure without obligation



Heavy design; for connection to steel structures.
 All connections secured against self-loosening:
 – Connection to the steel structure using adhesive-coated screws
 – Round conductor connection using spring washer
 Suitable for use in hazardous area zone 2/22.

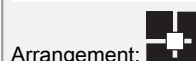

Type	AK 6.10 KSV FER S KBF18 35 V2A
Part No.	372 179
Clamping range	18-35 mm
Material of clamp	StSt
Clamping range Rd	6-10 mm
Screw	M8 x 25 mm
Material of screw / nut	StSt
Version	with spring washer
Lightning current carrying capability (10/350 µs)	50 kA ^{*)}
Standard	EN 62561-1
Weight	333 g
Customs tariff number (Comb. Nomenclature EU)	85359000
GTIN	4013364463684
PU	10 pc(s)

^{*)} For exact assignment, see test certificate.

We reserve the right to introduce changes in performance, configuration and technology, dimensions, weights and materials in the course of technical progress. The figures are shown without obligation.