



EFPM M10 12 V4A L230 STTZN (478 011)

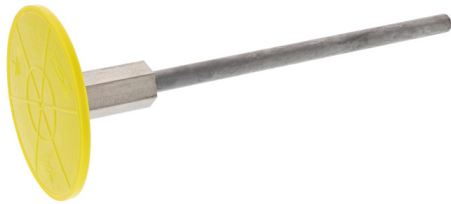
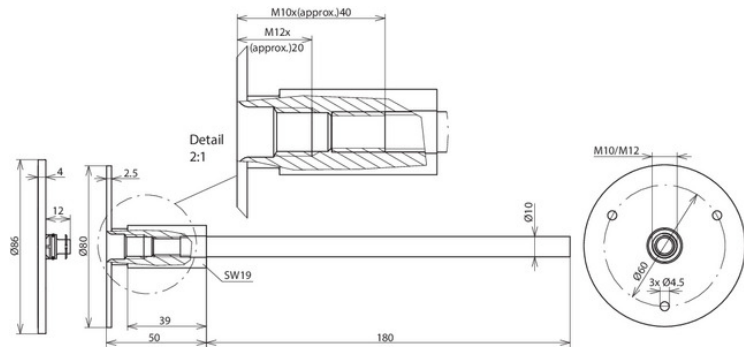

Figure without obligation



Type	EFPM M10 12 V4A L230 STTZN
Part No.	478 011
Connection thread	M10 / M12
Material of plate	StSt (V4A)
Material No.	1.4571 / 1.4404 / 1.4401
ASTM / AISI:	316Ti / 316L / 316
Material of shaft	St/tZn
Connection plate Ø	80 mm
Dimensions of connecting shaft (Ø / length)	10 / 180 mm
Short-circuit current (AC 50 Hz / DC) (1 s; ≤ 300 °C)	6.5 kA
Minimum lengths of M10 screws	35 mm (thread length 40 mm)
Minimum lengths of M12 screws	15 mm (thread length 20 mm)
Standard	EN 62561-1
Weight	301 g
Customs tariff number (Comb. Nomenclature EU)	85359000
GTIN	4013364033054
PU	25 pc(s)

We reserve the right to introduce changes in performance, configuration and technology, dimensions, weights and materials in the course of technical progress. The figures are shown without obligation.