



ERS 55 AB11 STTZN (410 134)

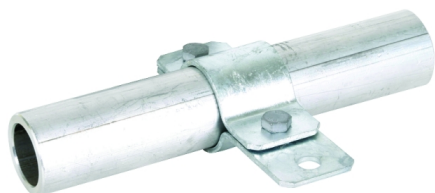
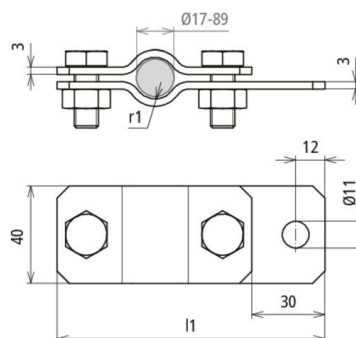

Figure without obligation



Arrangement:

Type	ERS 55 AB11 STTZN
Part No.	410 134
Clamping range pipe Ø	55 mm
Material	St/tZn
Screw	M10 x 25 mm
Material of screw / nut	St/tZn
Dimensions (l1 x r1)	145 x 27.5 mm
Lightning current carrying capability (10/350 µs)	100 kA ^{*)}
Standard	EN 62561-1
Weight	312 g
Customs tariff number (Comb. Nomenclature EU)	85359000
GTIN	4013364026285
PU	1 pc(s)

^{*)} For exact assignment, see test certificate.

We reserve the right to introduce changes in performance, configuration and technology, dimensions, weights and materials in the course of technical progress. The figures are shown without obligation.