

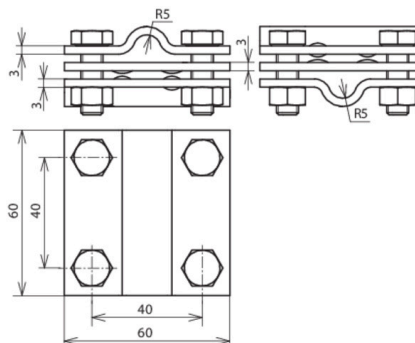

KS 8.10 8.10 FL30 ZP STTZN (319 201)



Figure without obligation



Type	KS 8.10 8.10 FL30 ZP STTZN
Part No.	319 201
Material of clamp	St/tZn
Clamping range Rd / Rd	8-10 / 8-10 mm
Clamping range Rd / FI	8-10 / 30 mm
Clamping range FI / FI	30 / 30 mm
Screw	M8 x 25 mm
Material of screw / nut	St/tZn
Dimensions	60 x 60 x 3 mm
Intermediate plate	yes
Lightning current carrying capability (10/350 µs)	100 kA ^{*)}
Standard	EN 62561-1
Short-circuit current (AC 50 Hz / DC) (1 s; ≤ 300 °C)	14 kA
Zinc coating acc. EN 1461	~50 µm
Weight	320 g
Customs tariff number (Comb. Nomenclature EU)	85359000
GTIN	4013364024519
PU	25 pc(s)

^{*)} See test certificate for exact classification.

We reserve the right to introduce changes in performance, configuration and technology, dimensions, weights and materials in the course of technical progress. The figures are shown without obligation.