



KS 8.10 16 FL30 ZP STTZN (319 202)

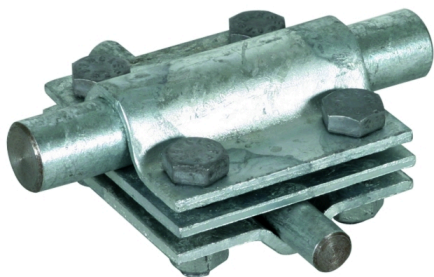
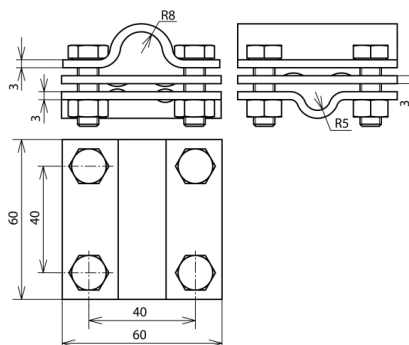

Figure without obligation



Type	KS 8.10 16 FL30 ZP STTZN
Part No.	319 202
Material of clamp	St/tZn
Clamping range Rd / Rd	16 / 8-10 mm
Clamping range Rd / FI	16 / 30 mm
Screw	⚙️ M8 x 25 mm
Material of screw / nut	St/tZn
Dimensions	60 x 60 x 3 mm
Intermediate plate	yes
Lightning current carrying capability (10/350 μs)	100 kA ^{*)}
Standard	EN 62561-1
Zinc coating acc. EN 1461	~50 μm
Weight	333 g
Customs tariff number (Comb. Nomenclature EU)	85359000
GTIN	4013364024526
PU	25 pc(s)

^{*)} See test certificate for exact classification.

We reserve the right to introduce changes in performance, configuration and technology, dimensions, weights and materials in the course of technical progress. The figures are shown without obligation.