

## PHE4 11 S (783 011)

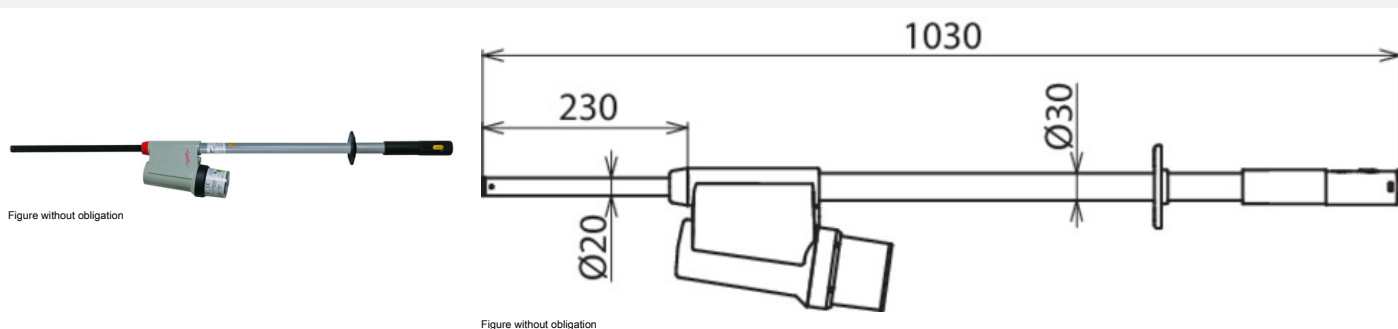

Type	PHE4 11 S
Part No.	783 011
Nominal voltage (U <sub>N</sub> )	11 kV
Type of voltage	a.c.
Frequency	50 Hz
Category	S
Total length (l <sub>o</sub> )	1030 mm
Insertion depth (l <sub>i</sub> )	230 mm
Length (handle) (l <sub>H</sub> )	265 mm
Standard	EN/IEC 61243-1 (DIN VDE 0682-411)
Temperature range	-25 °C ... +70 °C, climatic category N and W
Design	Complete
For use in wet weather conditions	Yes
For	Indoor and outdoor installations
Application	Switchgear installations and overhead lines
Design	Single-pole
Indication	Acoustic and visual
Sound level	> 67 dB(A) (visual indication and intermittent sound signal)
Self-testing element *)	Yes
Battery	Lithium AA 1.5 Volt
Material (test electrode)	Copper alloy/gal Sn
Material (test prod)	Glass-fibre reinforced epoxy resin tube
Material (indicator)	Plastic, fully insulated
Material (insulating stick)	Glass-fibre reinforced polyester tube
Diameter (insulating stick)	30 mm
Weight	1,25 kg
Customs tariff number (Comb. Nomenclature EU)	90303370
GTIN	4013364310131
PU	1 pc(s)

\*) all circuits including test prod

We reserve the right to introduce changes in performance, configuration and technology, dimensions, weights and materials in the course of technical progress. The figures are shown without obligation.