

FK MV 8.10 KBF0.7 10 CU (365 227)

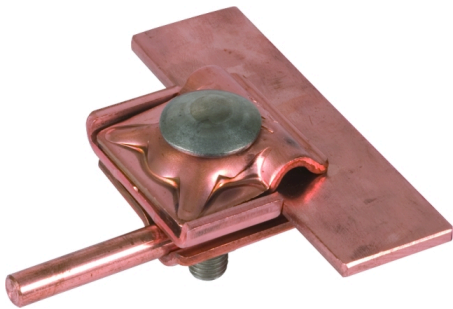
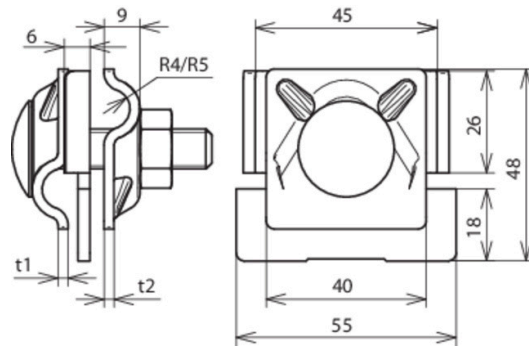

Figure without obligation



Arrangement:

Type	FK MV 8.10 KBF0.7 10 CU
Part No.	365 227 ✓
Clamping range of seam	0.7-10 mm
Material of clamp	Cu
Clamping range Rd	8-10 mm
Screw	⬆ M10 x 45 mm
Material of screw / nut	StSt
Material thickness	3 / 3 mm
Lightning current carrying capability (10/350 µs)	100 kA / 50 kA *)
Standard	EN 62561-1
Weight	197 g
Customs tariff number (Comb. Nomenclature EU)	85359000
GTIN	4013364096127
PU	50 pc(s)

*) For exact assignment see test certificate.

We reserve the right to introduce changes in performance, configuration and technology, dimensions, weights and materials in the course of technical progress. The figures are shown without obligation.