



FK ZS 7.10 KBF0.7 10 CU (365 047)

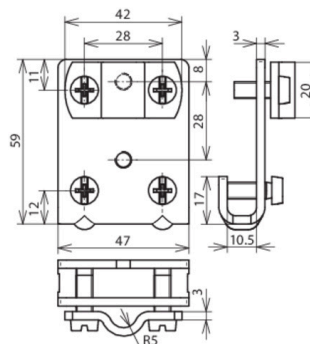
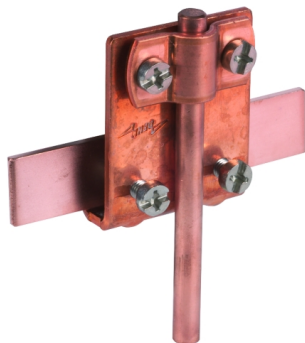

Figure without obligation

Type	FK ZS 7.10 KBF0.7 10 CU
Part No.	365 047
Clamping range of seam	0.7-10 mm
Material of clamp	Cu
Material thickness (t1)	3 mm
Clamping range Rd	7-10 mm
Screw	⚙ M6 x 16 mm
Material of screw / nut	StSt
Lightning current carrying capability (10/350 μs)	50 kA *)
Standard	EN 62561-1
Weight	139 g
Customs tariff number (Comb. Nomenclature EU)	85359000
GTIN	4013364069046
PU	50 pc(s)

*) For exact assignment see test certificate.

We reserve the right to introduce changes in performance, configuration and technology, dimensions, weights and materials in the course of technical progress. The figures are shown without obligation.