

AKK AL B11.11 KBF 3 20 STTZN (372 330)

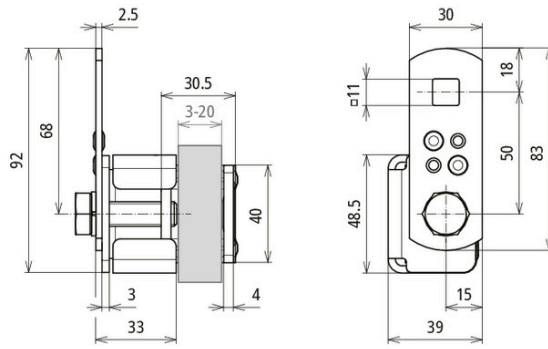

Figure without obligation



To penetrate the surface protection with the screw, the washer underneath the spring washer must be removed.



Arrangement:

Type	AKK AL B11.11 KBF 3 20 STTZN
Part No.	372 330
Clamping range	3-20 mm
Material of clamp	St/tZn
Screw	M10 x 35 mm
Screw / spring washer material	StSt
Type of connection	Releasable connection
Penetration of surface protection	Up to 0.2 mm with blade or blade and screw
Connection with	Connection bracket
Connection bracket square hole	11x11 mm
Lightning current carrying capability (10/350 µs)	50 kA 100 kA *)
Standard	EN 62561-1
Weight	278 g
Customs tariff number (Comb. Nomenclature EU)	85359000
GTIN	4013364515758
PU	25 pc(s)

*) For exact assignment, see test certificate.

We reserve the right to introduce changes in performance, configuration and technology, dimensions, weights and materials in the course of technical progress. The figures are shown without obligation.